

GO RHINO®

INSTALLATION INSTRUCTIONS



PART NO.

- 20412974T/ PC

PRODUCT DESCRIPTION:

- Go Rhino E-1 Electric Running Board

VEHICLE APPLICATION

- Ford Bronco 4 Door

PRODUCT SAFETY & LEGAL DISCLAIMER

- **IMPORTANT READ ALL INSTRUCTIONS CAREFULLY BEFORE INSTALLING, FAILURE TO DO SO MAY CAUSE PERSONAL INJURY OR DAMAGE TO PRODUCT AND/OR PROPERTY.**
- **Review the product package and contents prior to beginning the installation.** Take care when opening the packaging and removing items. If a return is needed you will want to return the product in its original packaging if possible.
- This instruction guide is provided as a GENERAL installation guide, some vehicles vary dimensionally and may require additional steps.
- Test fit the product on the vehicle prior to any third party modifications and or finishing. The manufacturer and/or distributors do not accept responsibility for third party charges, labor and or third part replacement modifications. Some modifications may void the factory warranty.
- Exercise due-diligence when installing this product. The manufacturer and distributors of this product do not accept any responsibility for vehicle damage or personal injury resulting from the installation of this product. Careless installation and operation can result in serious injury or equipment damage.
- This product is for general off-road use. All liability for installation and use rests with the owner/operator.
- **INSTALLER:** Once installation is complete, please return this guide along with other documentation included in this product back to the consumer for future reference. The manufacturer/distributors of this product do not guarantee this particular version will be available at a later date.

© 2016 Go Rhino Products. All rights reserved

www.gorhino.com

589 W. Apollo St., Brea, CA 92821

P: 888 427 4466



INSTALLATION INSTRUCTIONS

INJURY HAZARD

Please complete a shop and tool inspection prior to beginning the installation.

- Always make sure you have a clean, dry and well lit work area.
- Always remove jewelry, loose fitting clothing and wear protective gloves and eye protection.
- Always use extreme caution when jacking or raising a vehicle for work. Set the emergency brake and use tire/wheel blocks and jack stands. Refer to the vehicle manufacturer hand book. Utilize the vehicle manufacturers designated lifting points.
- Always use appropriate and adequate care in lifting parts during disassembly and installation. Seek help in lifting heavy or large items into place. Utilize jacks and or lifting devices when available.
- Always insure products are secure during disassembly and installation.
- Always wear eye protection and take steps to protect any exposed skin during the installations. Drilling, cutting and grinding plastic and metal may create flying particles that can cause injury.
- Always use extreme caution when drilling, cutting and or grinding on a vehicle. Thoroughly inspect the area to be drilled, on both sides of material, prior to modification and relocate any objects that may become damaged.
- Always assemble and tighten all fasteners per the installation instructions.
- Always route electrical cables carefully. Avoid moving parts, parts that may become hot and rough or sharp edges.
- Always insulate and protect all exposed wiring and electrical connections.

MAINTENANCE AND CARE

- Always perform regular inspections and maintenance on mounts and related fasteners.
- Periodically check and tighten all fasteners.
- Stripped, fractured, or bent fasteners must be replaced.
- After washing the vehicle make sure to fully dry all surfaces.
- In areas with cold temperatures make sure to wash the product often to remove harmful materials used on road ways.
- Never use abrasive cleaners or polish compounds. Clean with a gentle soap and water. If you use wax use a non-abrasive automotive wax such as pure carnauba wax.

WARNING

Some products have been designed to work together with factory rear sensor systems, factory forward facing sensor systems and factory air bags.

- Installation of some of these products may alter the factory sensor system performance.
- Factory sensors may read shackles or hooks protruding from the fairlead and or tow hooks.
- All sensor testing is completed by Go Rhino Products and or third party testing labs on modified vehicles.
- Sensor sensitivity, factory sensor housing, orientation, and operating conditions are all variables that will influence functionality of the sensors.
- Installation of some product may effect the factory air bag systems.
- Some products allow the use of third party products such as winches, shackles, hooks, etc. Follow the respective manufacturers operating instructions for use with our products.
- Make sure to fully understand the product, it's intended use and operation prior to use.
- Above all... be safe!

GO RHINO®

INSTALLATION INSTRUCTIONS

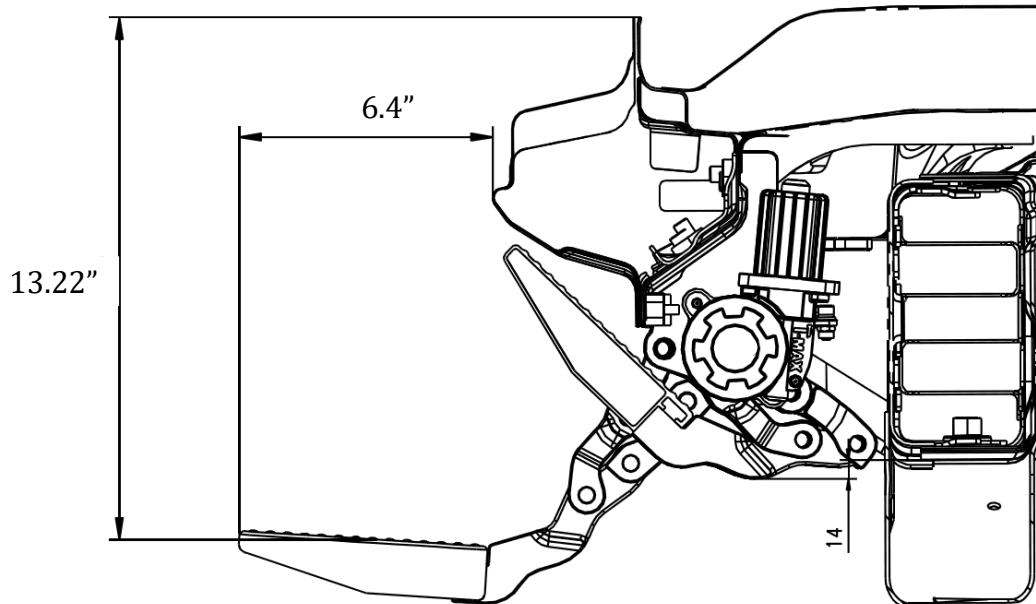

PRODUCT TECHNICAL SPECIFICATIONS

- Rated Voltage: 12V
- Load Rating: 600 lbs. per side
- Gross Weight: 55 lbs.
- Horizontal Extension: 6.4" (Horizontal distance between the edge of power board and the vehicle door when the board extends)
- Step Height: 13.22" (Vertical height difference between the edge of power board and the vehicle door while board extending.)

WARNING: Keep a minimum of 10" safe distance while the Go Rhino E-Board is operating to avoid any personal injury or damage to the running boards. Go Rhino E-Boards are not designed to provide vehicle body protection. Components can be damaged by hard impact or contact with foreign objects.



INSTALLATION INSTRUCTIONS

PARTS INCLUDED IN THIS LIST:

ITEM	QTY	DESCRIPTION
A	2	BOARD
B	1	DRIVER FRONT MOTOR
C	1	DRIVER REAR MOTOR
D	1	PASSENGER FRONT MOTOR
E	1	PASSENGER REAR MOTOR
F	1	CONTROL MODULE
G	1	HARNESS
H	2	WIRED MAGNETIC INDUCTION MODULE
I	4	DOOR MAGNET
J	4	LED LAMP
K	2	FUSE
L	1	E-BOARD MANUAL SWITCH
M	4	M10X30 HEX BOLT
N	10	M10X25 HEX BOLT
O	14	M10 FLAT WASHER
P	14	M10 LOCK WASHER
Q	8	M6X25MM SOCKET CAP SCREW
R	25	ZIP TIES
S	2	M8X25 HEX BOLT (NOT SHOWN)
T	2	M8 FLAT WASHER (NOT SHOWN)
U	2	M8 LOCK WASHER (NOT SHOWN)

Go Rhino recommends you, the installer, read this installation instruction manual from front to back before installing the product. You may also [click here](#) to view an installation video or visit <http://www.gorhino.com/Installation-Videos>.

TOOLS NEEDED FOR INSTALLATION:

- 5MM HEX KEY WRENCH (ALLEN WRENCH)
- 50/50 MIX OF ISOPROPYL ALCOHOL AND WATER
- 13MM SOCKET/ WRENCH
- 16MM SOCKET/ WRENCH
- PRY TOOLS

ESTIMATED TIME FOR INSTALLATION:

2-3 HOURS

If you need installation service for your new product, call the authorized distributor from whom you purchased the product or an authorized installation service company which can be found by calling toll free 1-888-427-4466

GO RHINO®

INSTALLATION INSTRUCTIONS

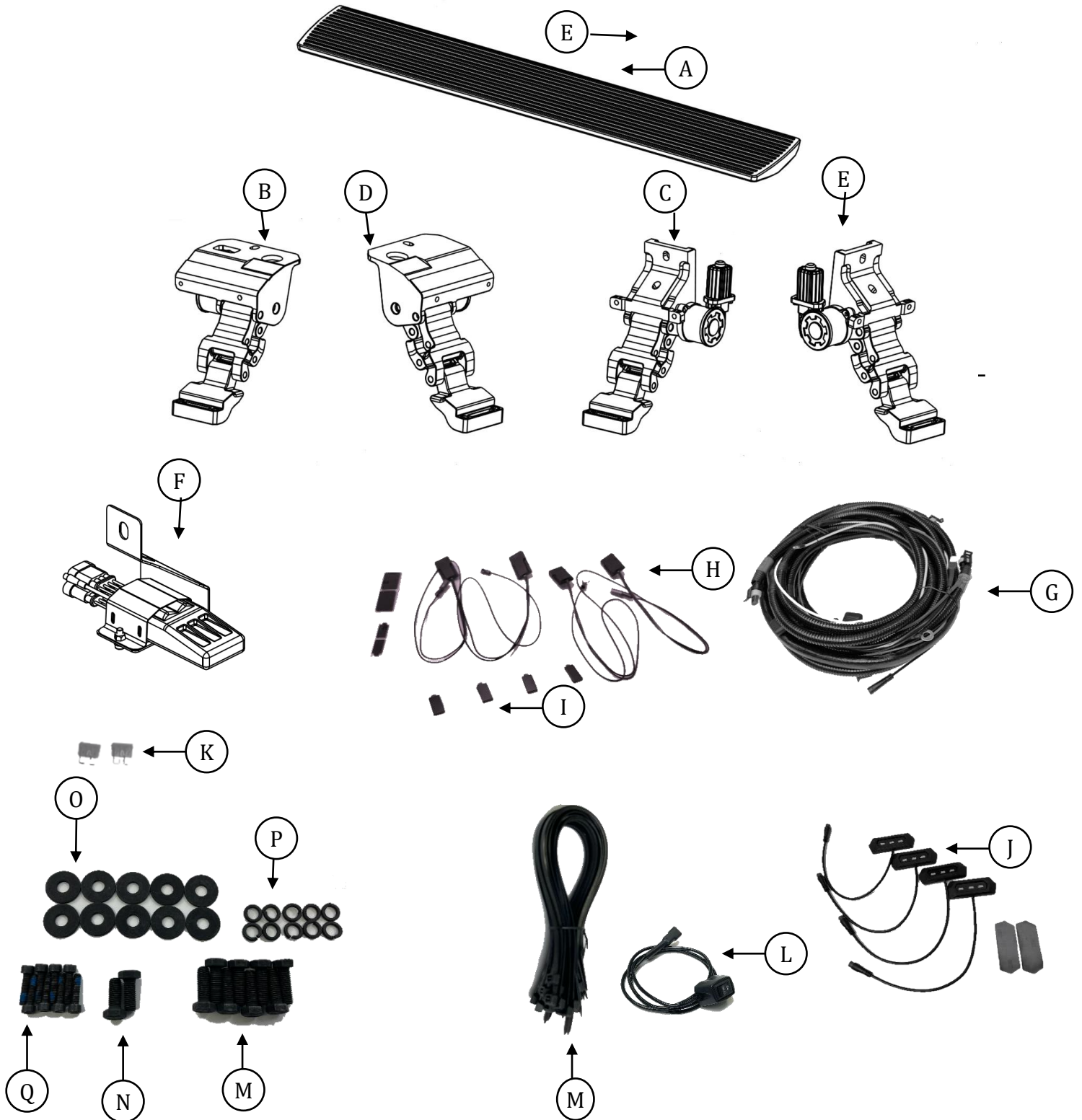

GORRHINO®

INSTALLATION INSTRUCTIONS

HARNESS LEADS:

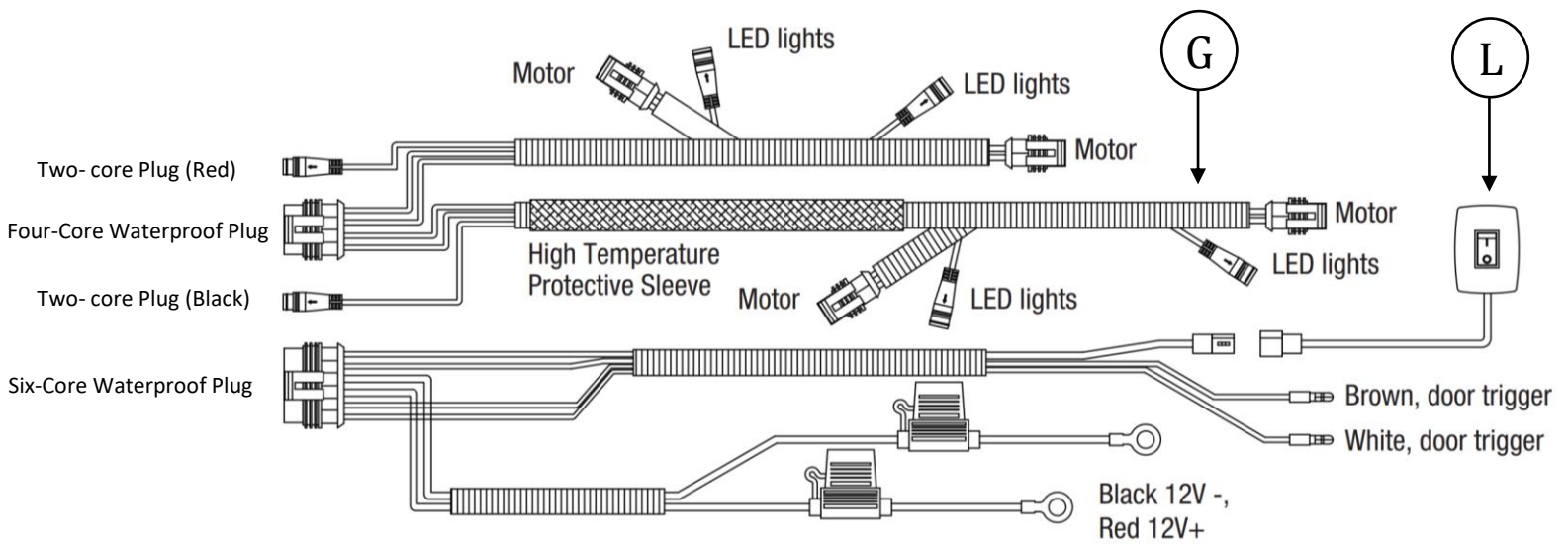

CONTROL MODULE :

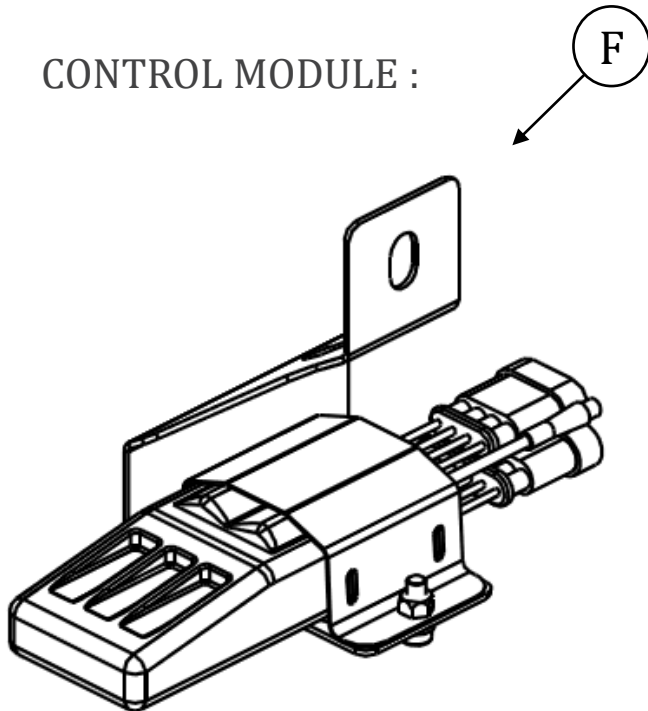

Notice: As shown in the picture, there is a four conductor plug, a six-conductor plug, a black two conductor plug, and a red two-conductor plug.

GO RHINO®

INSTALLATION INSTRUCTIONS

DRIVER SIDE INSTALLATION LOCATIONS

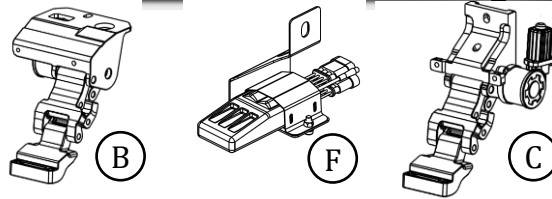
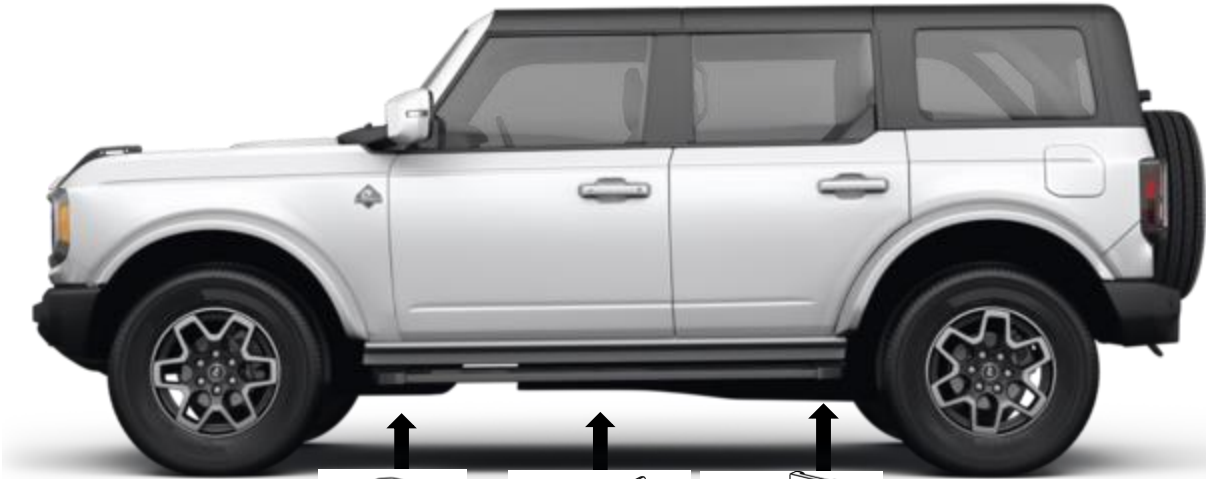

E-Board Motors point outwards from the tires

Step 1: Disconnect the battery. Begin with the negative battery terminal, followed by the positive terminal.

Step 2: On the Driver side, inspect the motor and controller mounting threaded holes. If the holes have a heavy paint buildup from the factory, clean the threads with a screw thread tap. board.

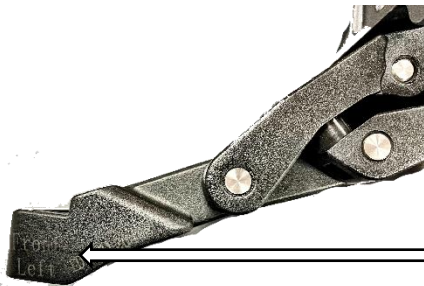

Note: Each motor is etched to call out what position it is installed in.

GO RHINO®

INSTALLATION INSTRUCTIONS

DRIVER SIDE INSTALLATION LOCATIONS

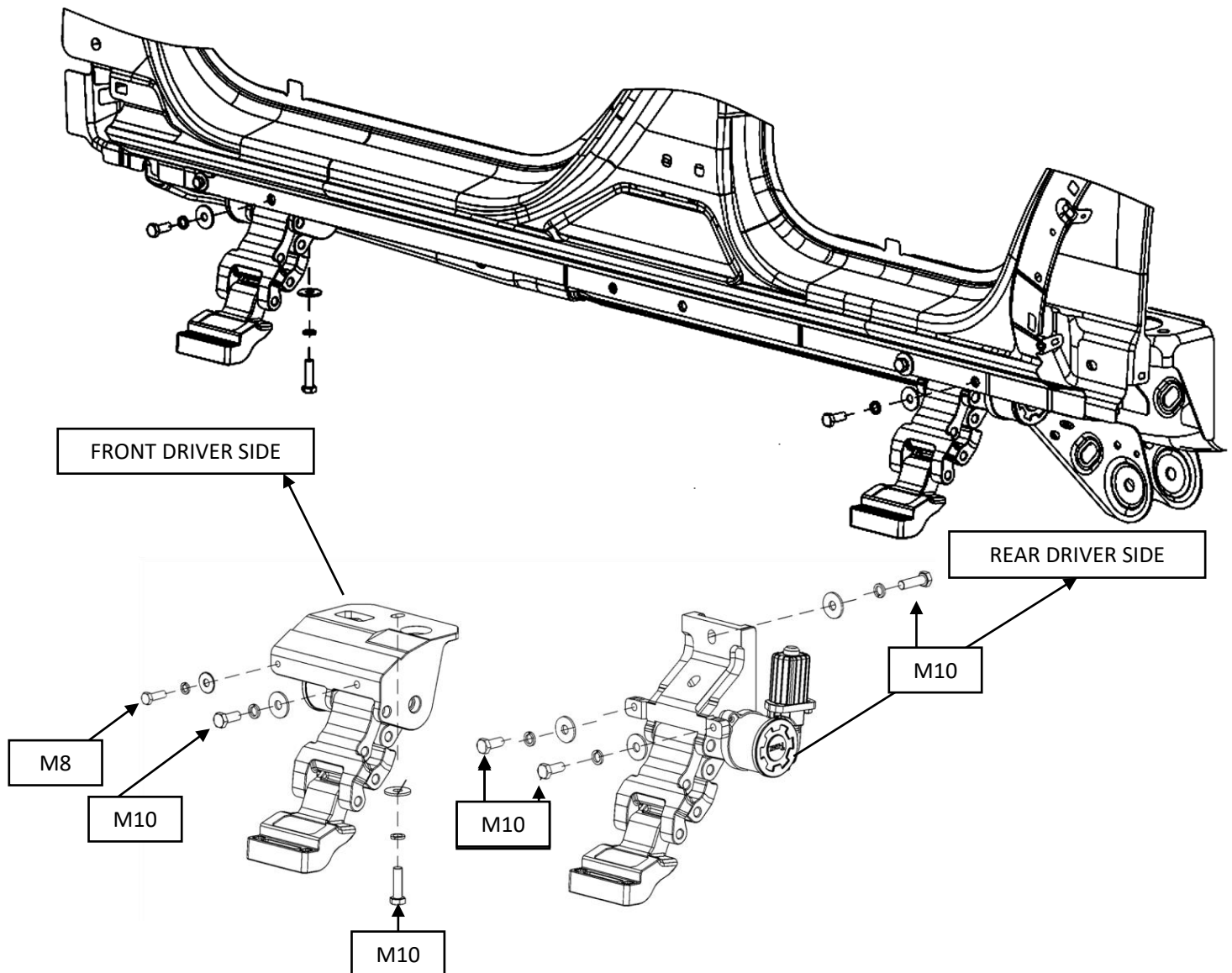

Step 3: Install the front hole of the driver motor using (1) M8x25MM hex bolts , (1) M8 Lock Washer, (1) M8 Flat Washer on the pinch weld. The rear hole uses (1) M10x25MM hex bolts , (1) M10 Lock Washer, (1) M10 Flat Washer on the pinch weld and (1) M10x35MM hex bolts , (1) M10 Lock Washer, (1) M10 Flat Washer on the rocker panel, to fasten the motor to the vehicle. The hardware should be hand tightened only until snug. This will allow the motor assembly to move and align easier when installing the running board.

Step 4 : Install the rear driver side motor using (2) M8x25MM hex bolts , (2) M8 Lock Washer, (2) M8 Flat Washer on the pinch weld and (1) M10x35MM hex bolts , (1) M10 Lock Washer, (1) M10 Flat Washer on the rocker panel, to fasten the motor to the vehicle. The hardware should be hand tightened only until snug. This will allow the motor assembly to move and align easier when installing the running board.

GO RHINO®

INSTALLATION INSTRUCTIONS

DRIVER SIDE INSTALLATION LOCATIONS

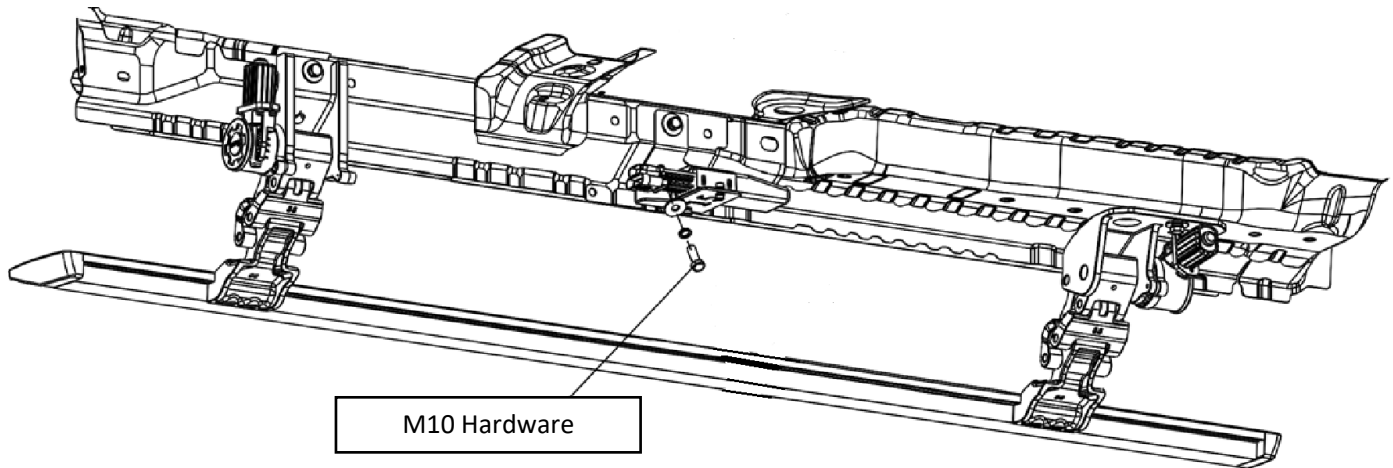

Step 5: Locate the threaded holes near the center of the cab on the Driver side of the vehicle. Install the controller bracket using (2) M10x25MM hex bolts M10 Lock Washer, M10 Flat Washer, to fasten the control module to the vehicle.

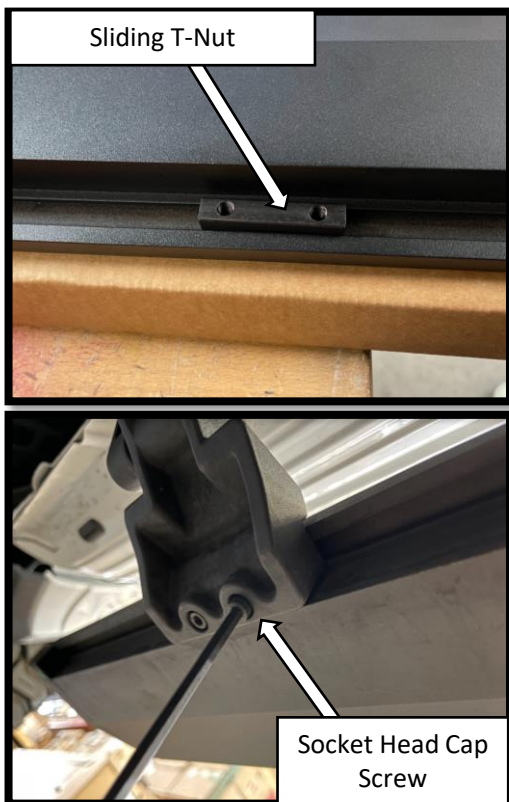

Step 6: Install the driver side running board. With assistance, begin by positioning the board on the front and rear motor assembly bases. Align the sliding T-Nut on the running board with the slots on the front and rear motor base. Once the T-Nuts are aligned, rotate the running board so that the T-Nuts set in the slots on the base of the arms. Repeat Steps 3-6 to install the motor linkage assemblies and running board on the Driver side.

Step 7: Determine where you want to position the board and secure the running board to the arms using the (2 per bracket) M6x25 socket head cap screws. Using a torque wrench, tighten to 9 ft-lbs. Step # With the running board is installed, fasten the hardware on the Driver side front and rear motor assemblies. Using a torque wrench, tighten the mounting hardware to 18 ft-lbs.

GO RHINO®

INSTALLATION INSTRUCTIONS

PASSENGER SIDE INSTALLATION LOCATIONS

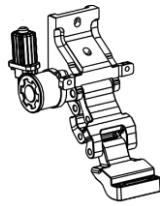
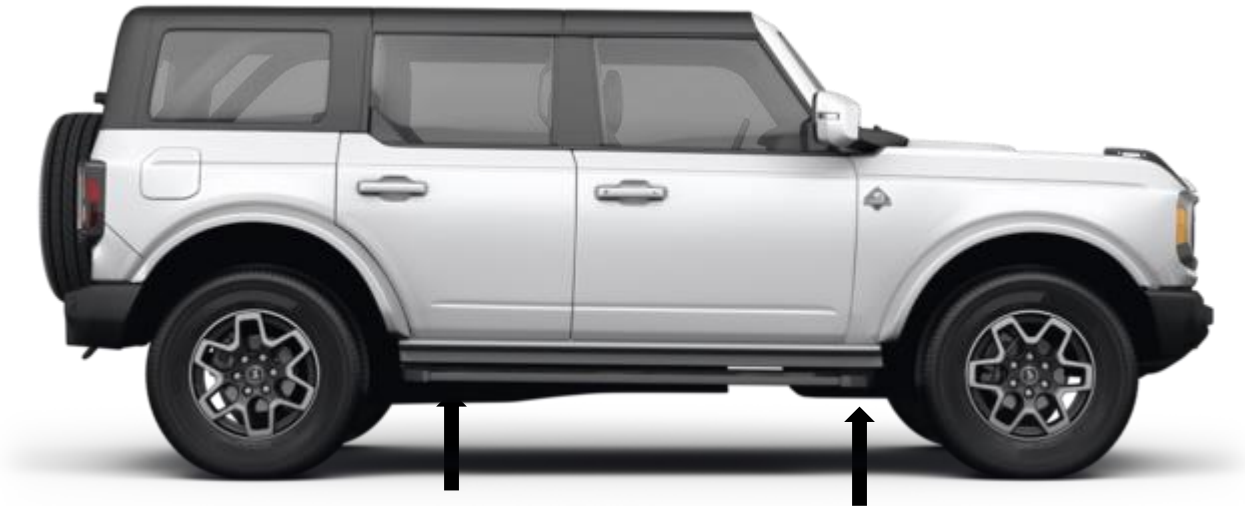

D

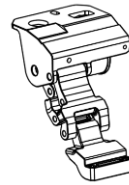

E

E-Board Motors point outwards from the tires



Step 8: Repeat Steps 1-4 to install the motor linkage assemblies on the passenger side. Repeat steps 6-7 to install running board on the Passenger side.

GO RHINO®

INSTALLATION INSTRUCTIONS

Wiring your E-Boards

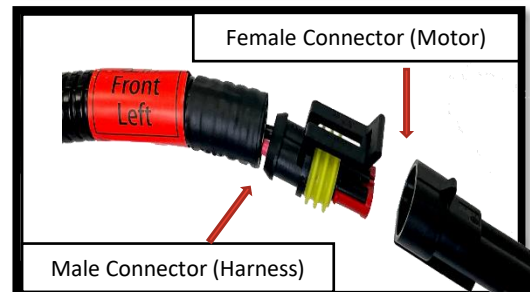
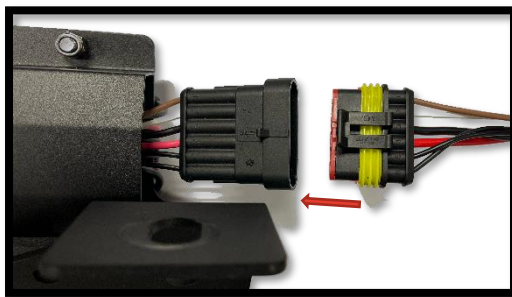
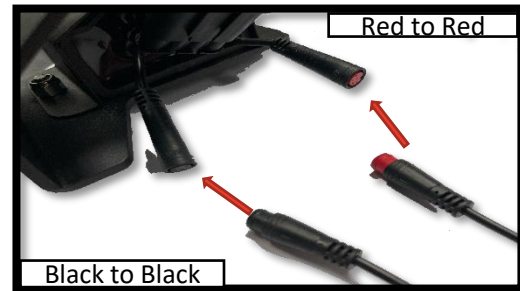
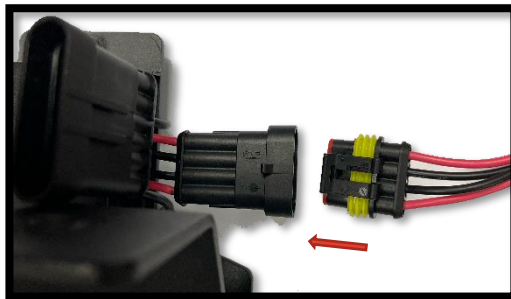
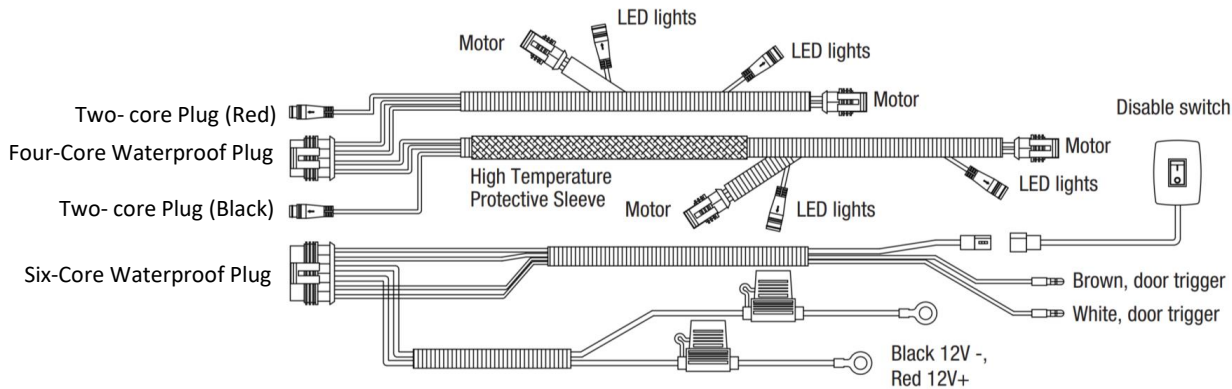

Step 9: With the control module installed, plug in the harness connectors to the corresponding connectors. On the round connectors, make sure you plug in red to red and black to black. Route the electrical harness from the controller along the frame rail of the truck. Connect the male plug connector on the wire harness into the female socket on the motors. The harness is labeled to show where to plug each male connector to the female connector. For example, Front Left is for the front Driver side motor and Rear Left for the rear Driver side motor. Use supplied zip-ties to secure harness to the frame rail.

Step 10: Connect the male plug connector on the wire harness into the female socket on the motors. The harness is labeled Front Right for the front Passenger side motor and Rear Right for the rear Passenger side motor.

GORRHINO®

INSTALLATION INSTRUCTIONS

Wiring your E-Boards

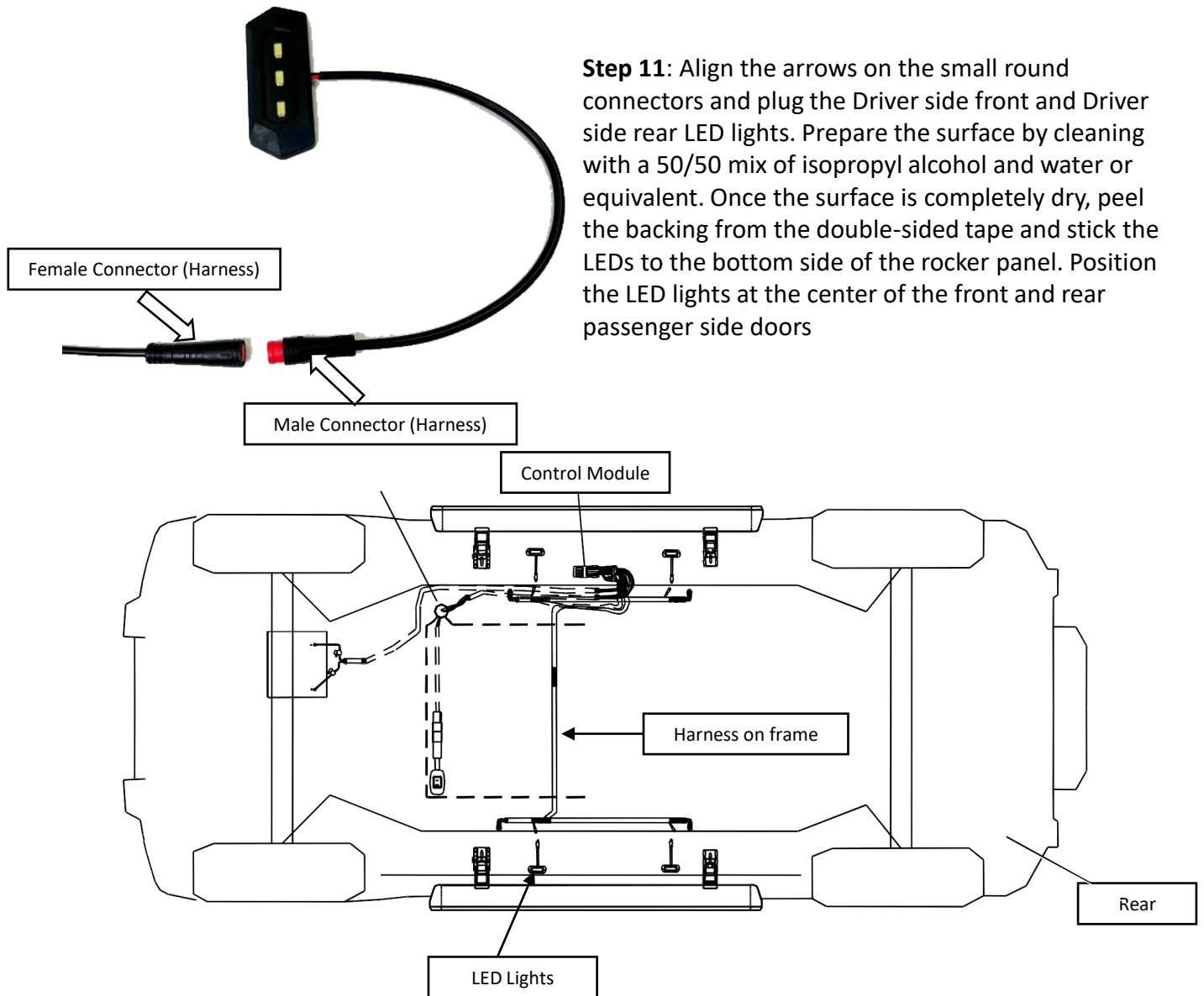

Step 11: Align the arrows on the small round connectors and plug the Driver side front and Driver side rear LED lights. Prepare the surface by cleaning with a 50/50 mix of isopropyl alcohol and water or equivalent. Once the surface is completely dry, peel the backing from the double-sided tape and stick the LEDs to the bottom side of the rocker panel. Position the LED lights at the center of the front and rear passenger side doors

Step 12: Route the motor and LED wire harness from the controller to the Passenger side frame rail of the vehicle. When routing the harness keep clear from any moving parts and avoid direct contact with the exhaust system.

GO RHINO®

INSTALLATION INSTRUCTIONS

Wiring your E-Boards

Step 13: On the driver side, remove the front kick panel, front door sill trim panel, and b-pillar trim panel. Pull the front driver carpet back and remove the grommet under the front driver side seat as shown (this plug is directly above the control module location) . Feed the door trigger signal wires (white and brown) and the disable switch wires (two black wires) into the cab. Seal around the wires using RTV silicone adhesive to prevent water intrusion.

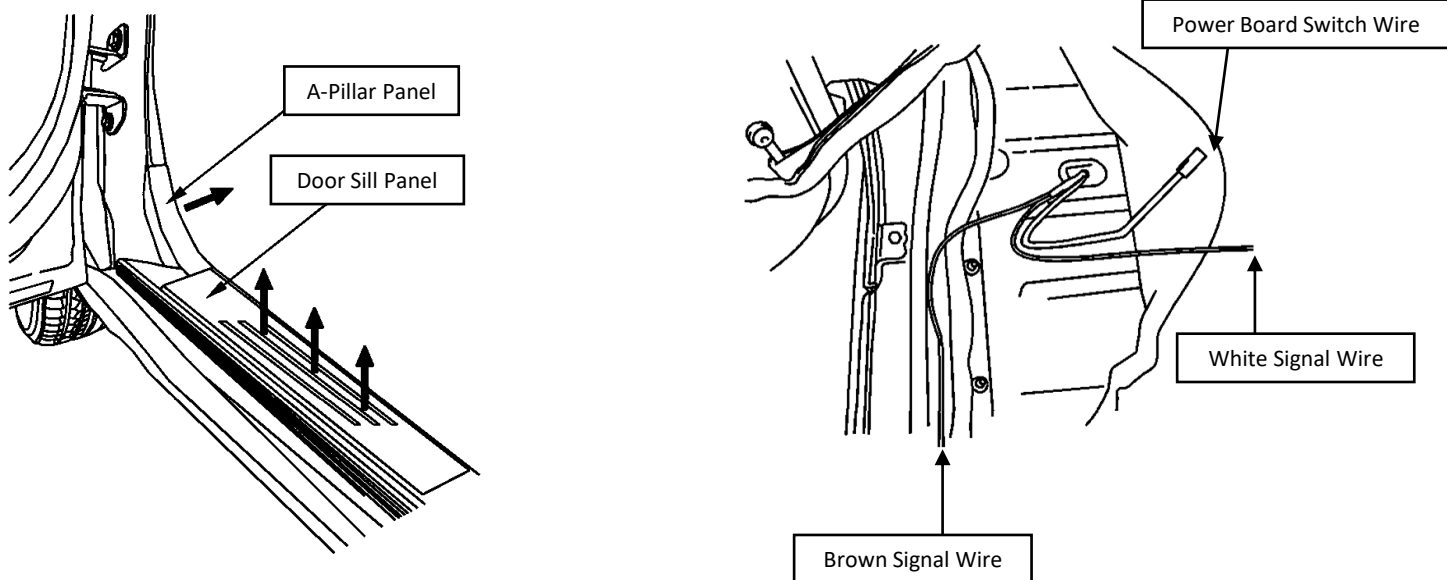
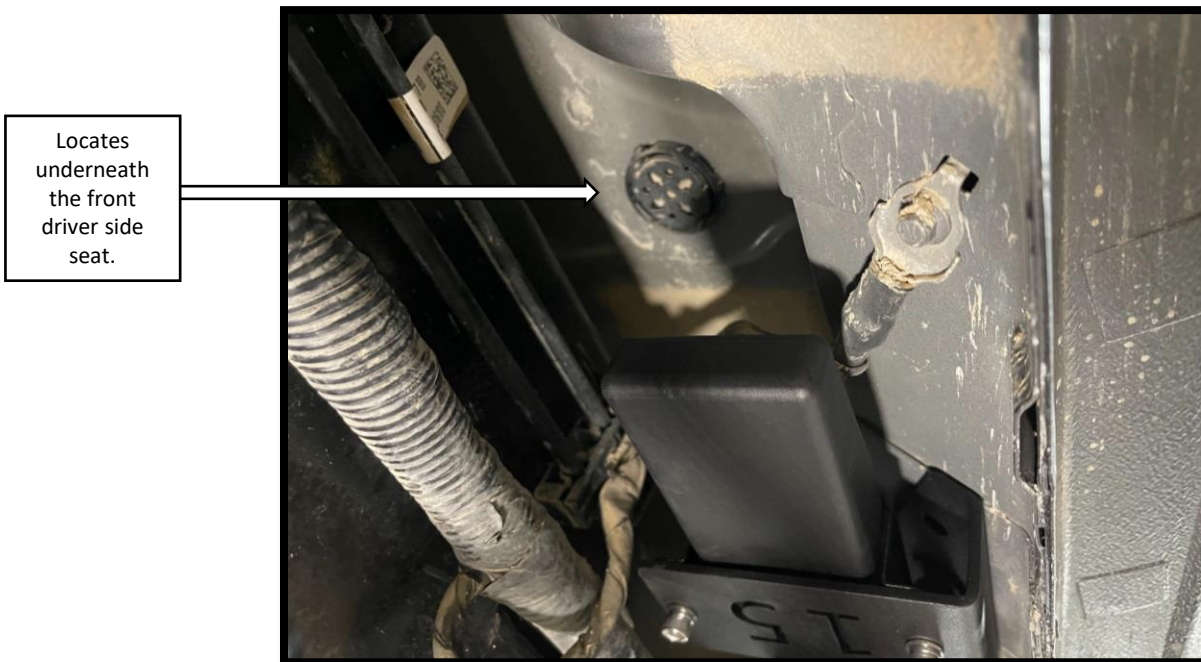

GO RHINO®

INSTALLATION INSTRUCTIONS

Wiring your E-Boards

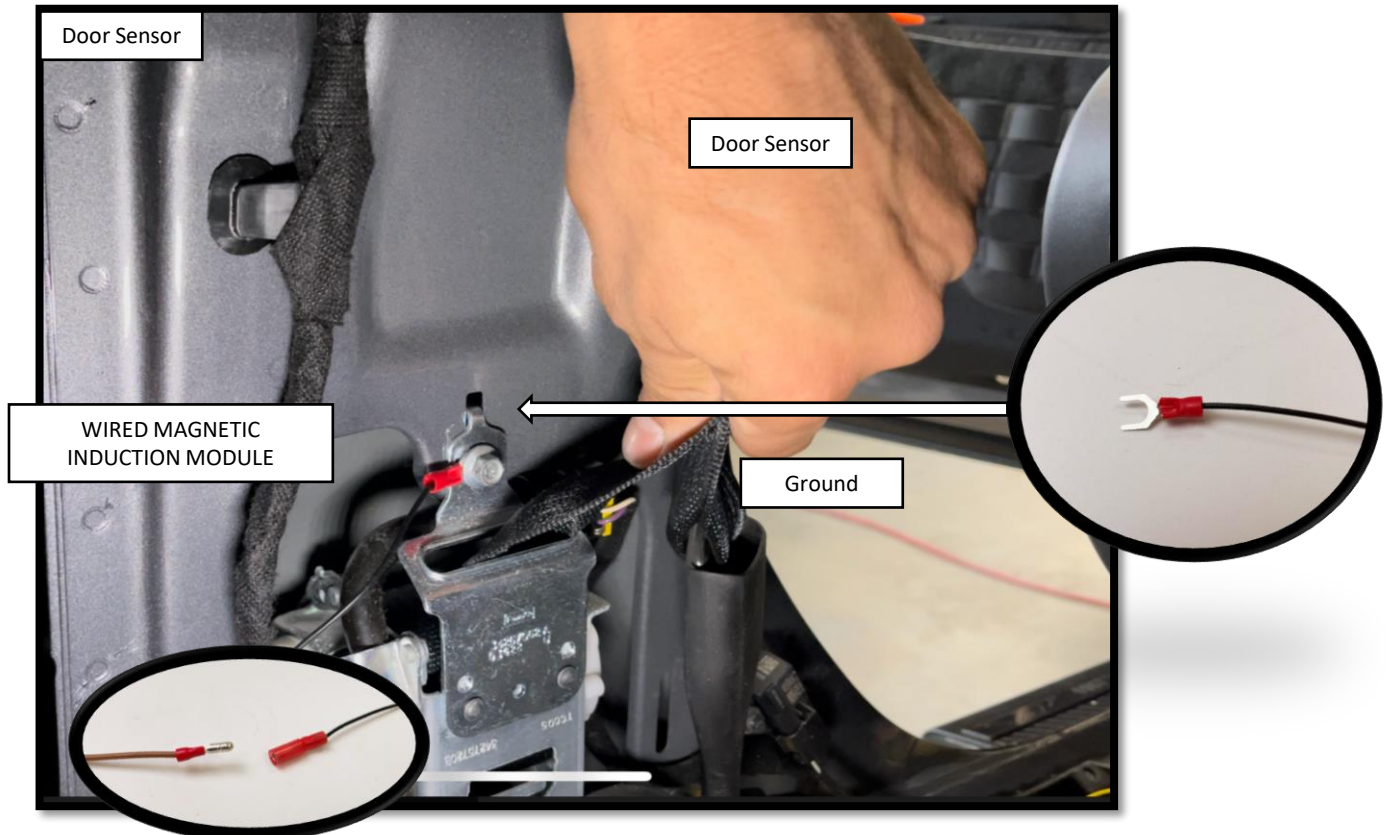

Step 14: The door trigger sensor harness will need a ground connection to the vehicle. Locate the seat belt assembly at the driver side b-pillar and install the ground wire under the top bolt of the seat belt assembly. Connect the snap-in bullet connector to the brown wire on the Passenger side b-pillar.

Step 15: Route the driver side door trigger wire (brown) towards the driver side b-pillar. Route the passenger side door trigger wire (white) and the black disable switch wires under the center console to the left side of the vehicle. The white wire needs to go to the passenger side b-pillar, the black wires will go to the center console.

GO RHINO®

INSTALLATION INSTRUCTIONS

Wiring your E-Boards



Step 16: FRONT DOOR Apply a vertically oriented strip of masking tape on the front driver side door using the deepest part of the latch as a reference point. Make a mark 6" below the center line of the latch. Prepare the surface by cleaning with a 50/50 mix of isopropyl alcohol and water or equivalent. Once the surface is completely dry, peel the backing from the double-sided tape and stick the magnet to the door. Align the top of the magnet with the 5" mark as shown.

Step 17: Apply a vertically oriented strip of masking tape on the door jamb using the outer edge of the front driver side door striker as a reference point. Make a mark 6" below the center line of the striker. Lift the bulb door seal to route the sensor wire underneath it. Prepare the surface by cleaning with a 50/50 mix of isopropyl alcohol and water or equivalent. Once the surface is completely dry, peel the backing from the double-sided tape and stick the sensor to the b-pillar. Align the top of the sensor with the 5" mark as shown.



Note: Magnet and Sensor Positioning. The measurement shown is for reference only and can be adjusted depending on the vehicle application. The magnet needs to align with the sensor in order to operate. With the magnets in position and the power switched on, test the boards by opening each door independently to ensure proper step function. Once all magnet locations are confirmed and the system is operating correctly, mark the magnet positions and permanently install using the round double-sided tape. If the boards do not deploy, inspect the magnet position and realign with the sensor.

INSTALLATION INSTRUCTIONS

Wiring your E-Boards

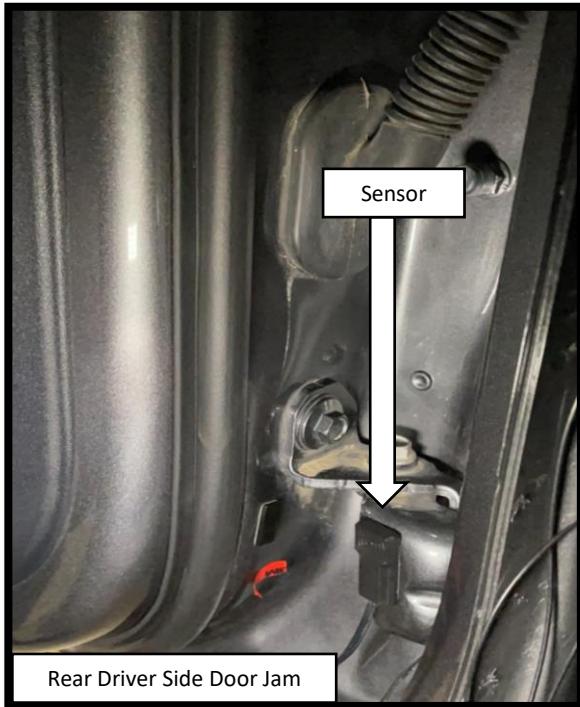

Step 18: REAR DOOR Prepare the surface of the bottom door hinge by cleaning with a 50/50 mix of isopropyl alcohol and water or equivalent. Lift the bulb door seal to route the sensor wire underneath it. Once the surface is completely dry, peel the backing from the double-sided tape and stick the rear door sensor to the bottom door hinge.

Step 19: With the rear driver side sensor attached, you can determine the correct position for the door magnet. peel the backing from the double-sided tape and stick the magnet on the door.

Step 20: Repeat steps 14-19 to install the Passenger side door trigger sensors and magnets. The Passenger side door trigger harness is connected to the white wire that was routed under the carpet to the Passenger side b-pillar in Step 13

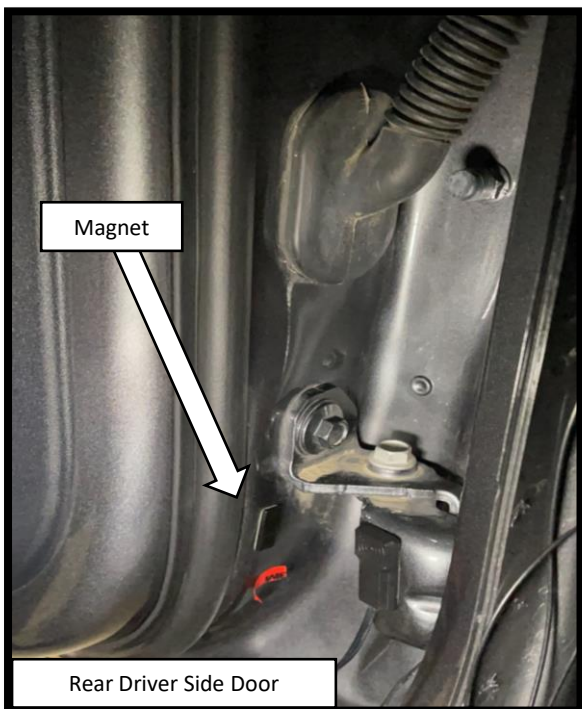

Note: Magnet and Sensor Positioning. The measurement shown is for reference only and can be adjusted depending on the vehicle application. The magnet needs to align with the sensor in order to operate. With the magnets in position and the power switched on, test the boards by opening each door independently to ensure proper step function. Once all magnet locations are confirmed and the system is operating correctly, mark the magnet positions and permanently install using the round double-sided tape. If the boards do not deploy, inspect the magnet position and realign with the sensor.

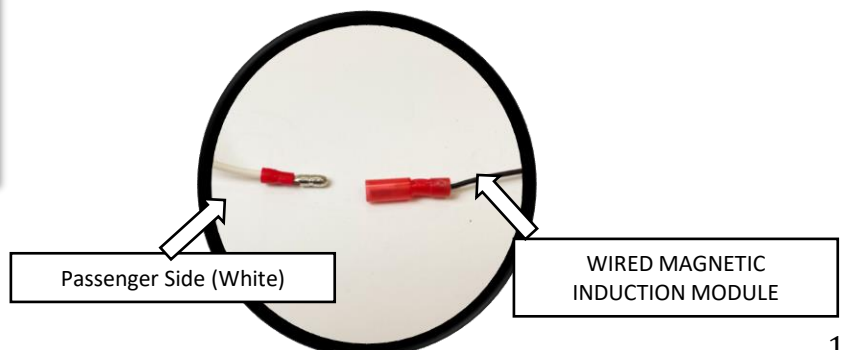

GO RHINO®

INSTALLATION INSTRUCTIONS

Wiring your E-Boards



Step 21: Locate the black wires for the disable switch and feed them to your desired mount location. Prepare the surface by cleaning with a 50/50 mix of isopropyl alcohol and water or equivalent. Once the surface is dry, peel the backing from the double-sided tape and stick the disable switch on the lower dash panel. Plug the disable switch connector into the black wire harness and tuck the extra wire behind the lower dash panel.

Step 22: Remove the 20 Amp fuses from the main positive and negative 12V power leads on the main harness. Route the power wires over the wheel well and into the engine compartment. Connect the ring terminals to the battery positive and negative terminals. Install the 20 Amp fuses back into the main negative and positive power lead fuse holders. Connect the battery terminals. Begin with the positive terminal followed by the negative terminal.

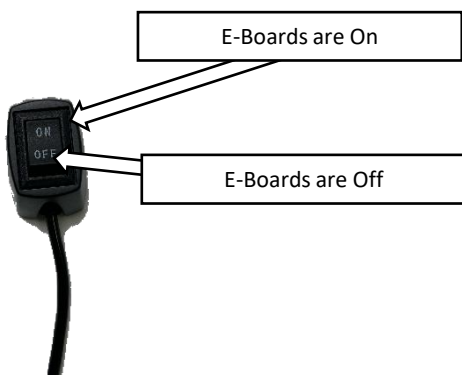
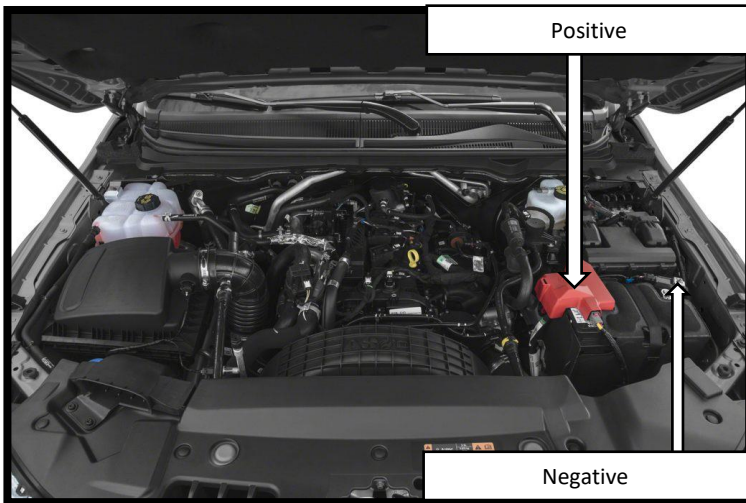

Step 23: Open the Driver side door and keep the door open. Flip the disable switch to the Off position. This will signal the running boards to retract to the stowed position and it will disable any further operation until the switch is flipped to the On position.



INSTALLATION INSTRUCTIONS

LIMITED WARRANTY

Go Rhino warrants to Buyer that for a period of five (5) years from the date of shipment of the product(s) ("Warranty Period") for black finishes and chrome finishes, that such products will materially conform to the specifications set forth in Go Rhino's specifications in effect as of the date of shipment(s) and will be free from material defects in material workmanship.

Go Rhino warrants to Buyer that for the life of the product(s) from the date of shipment of the product(s) ("Warranty Period") for polished stainless steel finished products purchased after April 2004, that such products will materially conform to the specifications set forth in Go Rhino's specifications in effect as of the date of shipments and will be free from material defects in material workmanship.

Warranty claims must be accompanied with the original invoice and photos of the product. It is the customer's responsibility to clean regularly and protect finish with regular applications of a nonabrasive polish that is compatible with the product's finish.

This warranty covers the cost of the product only and does not include the cost of removal, installation, third party modifications or shipping of the product. In no event shall Go Rhino be liable to buyer or any third party for any damage or harm caused by the product or use thereof, regardless of weather such damages were foreseeable and whether or not Go Rhino has been advised of the possibility of such damages, not withstanding the failure of any agreed or other remedy of its essential purpose. This warranty is void if the product shows signs of alteration, misuse, mishandling, improper care, neglect, improper application and/or damage due to improper installation.

With respect to any such product(s) during the limited warranty period, Go Rhino shall, in its sole discretion, either: (i) provide a one-time repair or replacement of such products (or the defective part) or (ii) credit or refund the price of such products at the pro rata contract rate provided that, if Go Rhino so requests, Buyer shall, at Go Rhino's expense, return such product(s) to Go Rhino. The remedies shall be the Buyer's sole and exclusive remedy and Go Rhino's entire liability for any breach of the limited warrant(ies).

Go Rhino disclaims all other warranties except to the extent that any such warranty cannot be validly disclaimed under applicable law.

Finish Limited Warranty:

Limited lifetime on stainless steel products (after April 2004)
5 year warranty on black powder coat products
5 year warranty on chrome products
This warranty does not cover exposed welds

Finish warranty covers peeling, flaking, or cracking. Washing all finishes regularly with car wash soap and rinsing well with water is the best method for maintaining the finish on your products. You must also protect the finish with nonabrasive automotive wax on a regular basis. The use of any compound which contains abrasives becomes a self-defeating exercise as the compound scratches the finish and opens it to corrosion. The use of harsh chemicals used to remove bugs and tar may also cause the finish to fail and should be avoided.

If you are unsatisfied with your purchase please contact the establishment you purchased the product from.

If you need to place a warranty claim or need assistance, the Go Rhino customer service team will answer any questions you may have. Please contact the Go Rhino customer service team at 1-888-427-4466 during normal business hours Monday thru Friday 7 am to 5 pm PST. You may also email warranty@gorhino.com. In order to better serve you please provide a copy of the original invoice / receipt, a photo of the issue you are experiencing and a photo of the vehicle the product is installed on.

All warranty returns must have an approved RGA number. The RGA number must be clearly marked on the exterior of the return package. All approved warranty returns must be shipped to Go Rhino Products, 1002 Carriers Drive, Laredo, Texas 78045.

PRODUCT REGISTRATION

Please remember to register your new purchase. You may register your product at www.gorhino.com. Registering your product may help speed any future warranty or customer service inquiries.

Thank you again for purchasing from Go Rhino Products

Please take a few minutes to view additional products for your vehicle and more at GORRHINO.com
These installation instructions are available on the Go Rhino web site along with installation videos for many of our products.

www.gorhino.com

www.bigcountryauto.com

www.gorhinopd.com